

Log cabins and garden houses

accessories and more!

collection 2024



TUINDECO

LEADING IN GARDEN PRODUCTS

Impregnating your log cabin or garage

Using treated lumber will protect the wood from water, mould, and rot; this does not mean it is maintenance-free. Pressure treatment is a pre-treatment and offers basic protection. We recommend treating the wood regularly with a stain or paint to maintain protection.

All our log cabins are available impregnated. Impregnation increases the life span of the log cabin as this protects the wood against fungus and other processes that may damage the wood. When an impregnated log cabin is delivered, it is ready to be constructed in your garden. Naturally, over time your impregnated log cabin will begin to show signs of weathering. We treat our log cabins in the following colours:

We recommend treating the cabin at least once a year

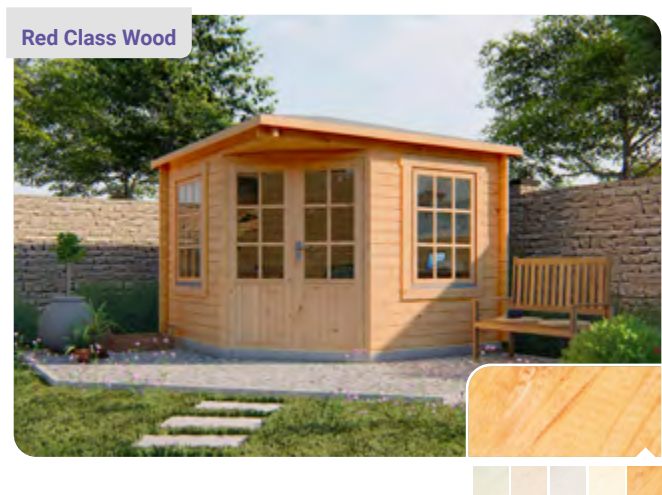
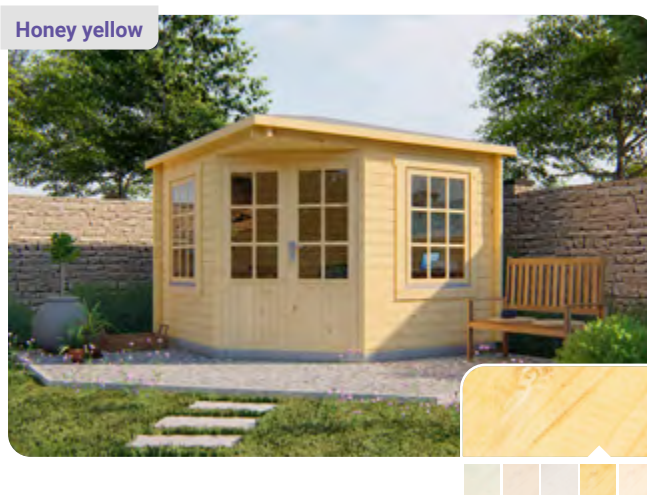
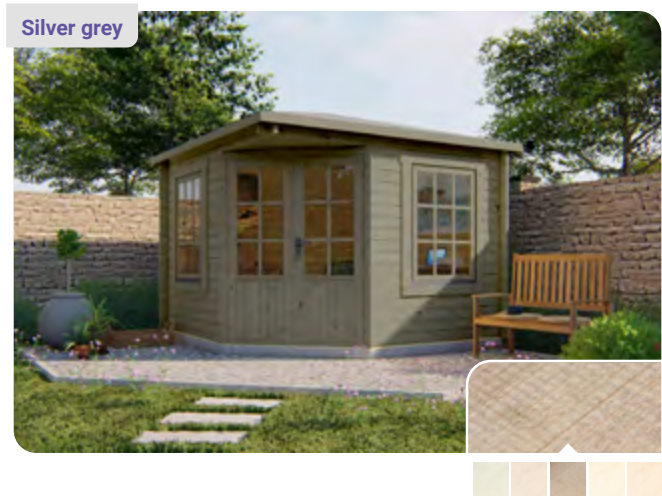
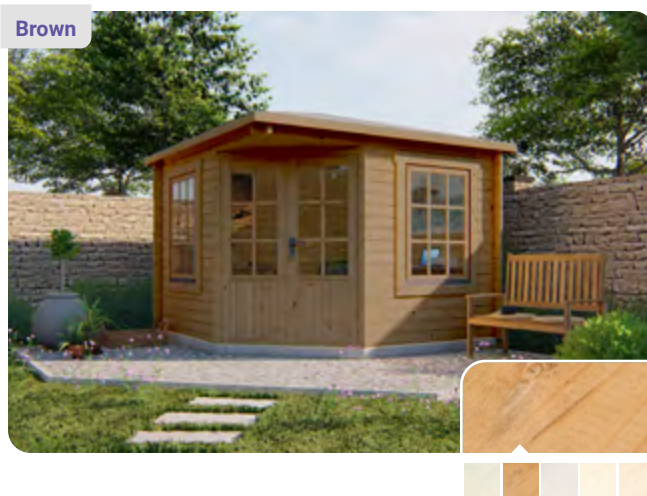
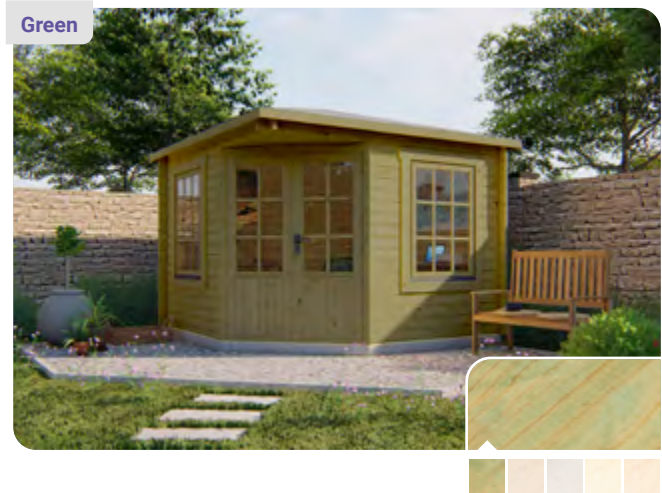



Casper log cabin,
pressure treated in the
colour Red Class Wood

Impregnating liquid

Extend the lifespan

Wood used in outdoor applications must be protected from the effects of weather. To this end, wood for log cabins, garden sheds, chalets, wall cladding, fences, etc. should be treated. We extend the service life of many of our products by treating the wood. You can also choose to treat the wood yourself, before or after installation. This can be done with preservatives or staining. We offer the following impregnation products.

P019695	Green 0.75ltr
P019688	Green 2.5ltr
P019697	Clear 0.75ltr
P019690	Clear 2.5ltr
P019699	Black 0.75ltr
P019692	Black 2.5ltr
P019698	Silver grey 0.75ltr

P019691	Silver grey 2.5ltr
P019696	Brown 0.75ltr
P019689	Brown 2.5ltr
P019700	Red Class Wood 0.75ltr
P019693	Red Class Wood 2.5ltr
P019701	Honey Yellow 0.75ltr
P019694	Honey Yellow 2.5ltr



Impregnation process

The log cabin is impregnated using the immersion/diffusion technique. Professional impregnation liquids are used for this with long-term effect against wood-damaging fungi. All parts of the log cabin are impregnated, including doors, windows, shutters, etc. The impregnating agent may affect the hardware in your log cabin. Parts that are ordered separately, such as a wooden floor, can also be impregnated. After impregnation, the cabin is dried naturally and repacked.



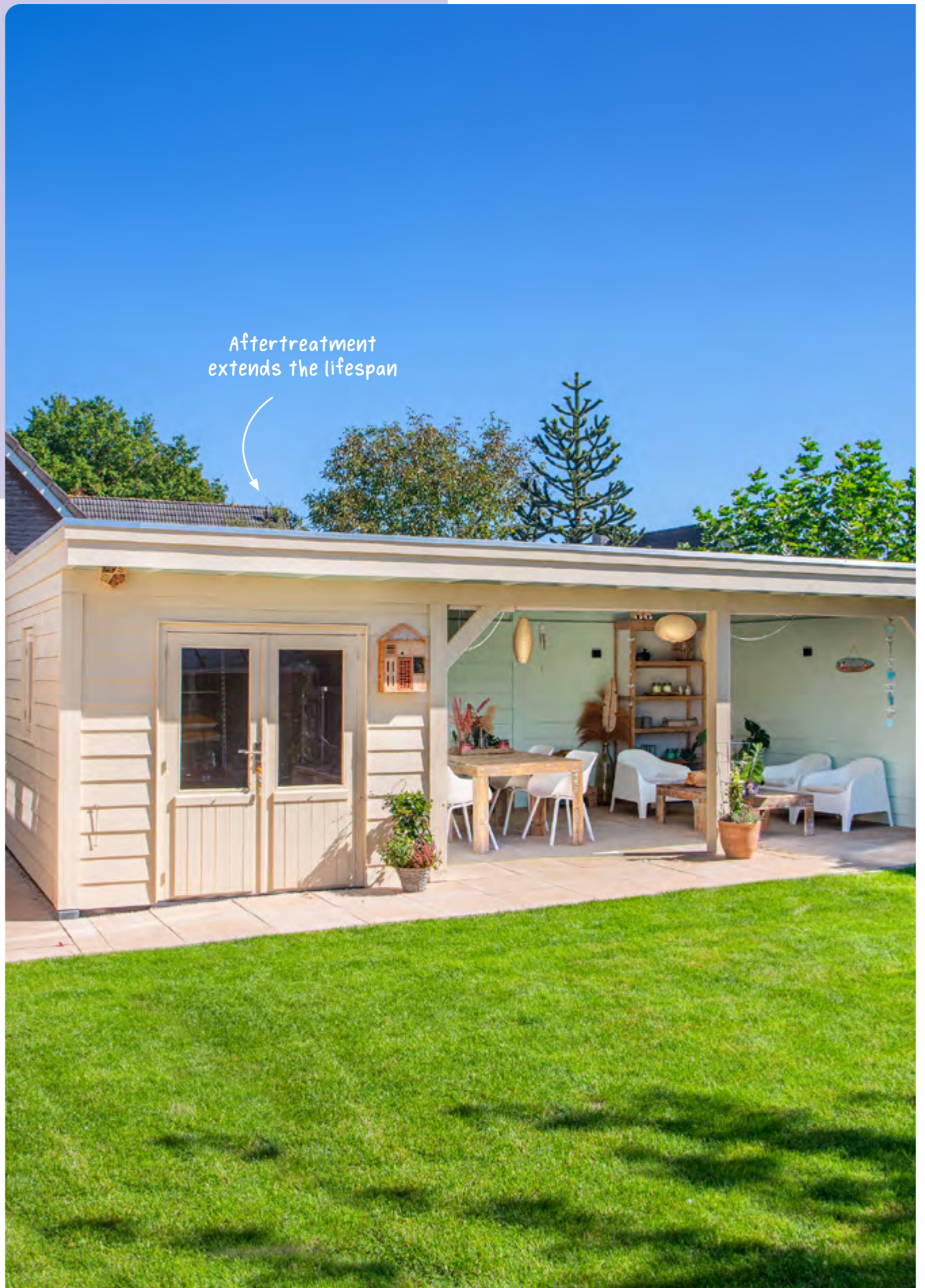

Aftertreatment
extends the lifespan



Carefree Protect

This is a revolutionary and unique product for maintaining both wood and concrete in optimal condition and providing it with very long-term protection against the effects of the weather, moisture penetration, UV rays and temperature variations. It is based on ultramodern nanotechnology, it is water based and does not contain any organic solvents. Carefree Protect provides a moisture-resistant finish to wood and concrete and is also resistant to algae, fungus and corrosion.

It does not have the disadvantage of stains, paints and coatings, such as blistering, color loss and regular maintenance. Carefree Protect prevents the unattractive calcium formation on concrete products.

It has a high penetration capacity whereby the structure of the treated product remains clearly visible. Carefree Protect does not require a primer or undercoat and can be applied directly to a clean and dry surface without any sanding being necessary.

Carefree Protect is ideally suited to the long-term protection and decoration of wooden products such as log cabins, garden fences, furniture, pergolas and decking Boards. It is not suitable for hardwood and modified types of wood.

Carefree Protect is also ideally suited for the long term protection and decoration of concrete and stony products such as paving, fences and roof tiles.

AVAILABLE COLORS



CAREFREE PROTECT

P019702	Black 1ltr
P019713	Black 2.5ltr
P019703	Transparent 1ltr
P019708	Transparent 2.5ltr
P019704	Anthracite 1ltr
P019715	Anthracite 2.5ltr
P019705	Pine 1ltr
P019709	Pine 2.5ltr
P019707	White 1ltr
P019711	White 2.5ltr
P019706	Concrete grey 1ltr
P019714	Concrete grey 2.5ltr
P019716	Light oak 1ltr
P019710	Light oak 2.5ltr
P019717	Green 1ltr
P019712	Green 2.5ltr

Applied on one side only to planed wood use mphasi. 1 liter per 6-7m²

Embalan

This is an opaque, silky-gloss paint that you can dilute with water. Embalan is highly elastic, moisture-regulating and water-repellent and shares several unique qualities with our Embadecor stains; such as, it does not peel and is UV-stable. Embalan forms a cocoon in which your wood is protected for many years. If applied correctly Embalan also prevents your wood from cracking. You should use a base insulation coat for the first layer under Embalan to ensure the best final result, for this, we recommend our Transparent Embalan Insulation Coat.

AVAILABLE COLORS

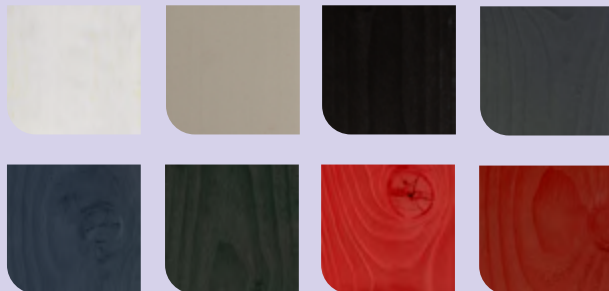

EMBALAN

P019677	White 2.5ltr
P019678	Creamy White 2.5ltr
P019679	Grey 2.5ltr
P019680	Black 2.5ltr
P019681	Blue-Grey 2.5ltr
P019682	Prussian blue 2.5ltr
P019683	Carriage green 2.5ltr
P019684	Red 2.5ltr
P019685	Red-brown 2.5ltr
P019687	Anthracite 2.5ltr
P019686	Insulation Coat 2.5ltr

Applied on one side only to planed wood use mphasi. 1 litre per per 4m²

Before applying the final colour of Embalan, we always recommend applying a coat of P019686 Insulating Primer first



Embadecor

This is a transparent product with active ingredients against the discolouration and damage of the wood through wood-consuming and surface fungi. These stains can be mixed with each other to create stunning and unique colours. Embadecor not only makes wood weatherproof, but it also enhances the natural characteristics by adding depth, texture and highlighting the beautiful structure of the wood. A unique quality of Embadecor is that it does not peel, it is UV-stable, emphasizes the grain and is water-repellent. It is suitable for all types of wood. Embadecor can be used as a primary coat for wood that is to be later treated with Embalan opaque paint.

EMBADECOR

P019664	Transparent 2.5ltr
P019665	Swedish red 2.5ltr
P019666	Light pine 2.5ltr
P019667	Pine 2.5ltr
P019668	Light oak 2.5ltr
P019669	Rustic Oak 2.5ltr
P019670	Teak 2.5ltr
P019671	Walnut 2.5ltr
P019672	Ebony 2.5ltr
P019673	Pine green 2.5ltr
P019674	Chestnut 2.5ltr
P019675	Mahogany 2.5ltr
P019676	Silver grey 2.5ltr

AVAILABLE COLORS

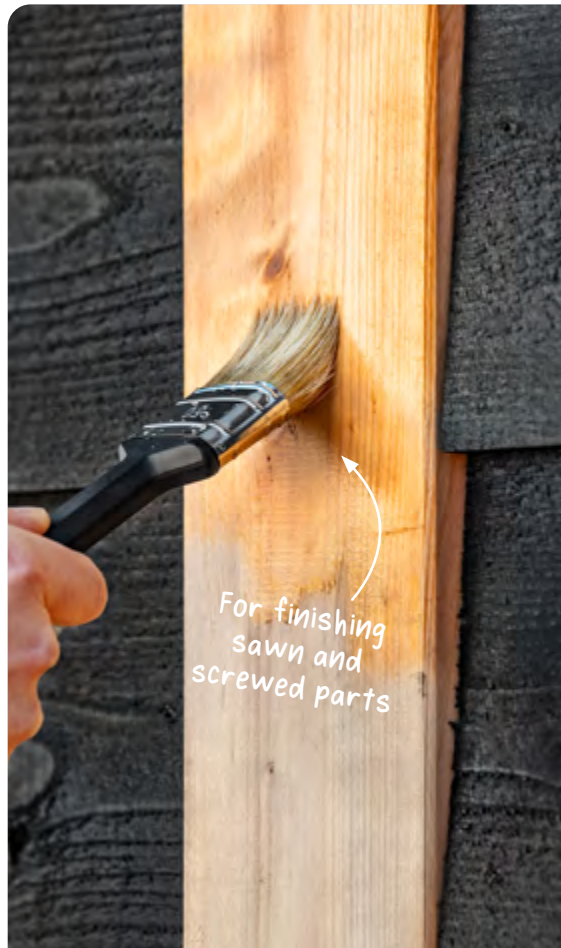

PAINT, STAIN AND OIL

P019660	Carefree Protect Douglas wood stain 0,75 ltr
P019661	Carefree Protect Douglas wood stain 2,5 ltr
P019662	Carefree Protect Scaffold white wash 0,75 ltr
P019663	Carefree Protect Scaffold grey wash 0,75 ltr
P006268	Carefree Protect paint grey 1 ltr
P006266	Carefree Protect paint black 1 ltr
P019655	Carefree Protect Black tar 0,75 ltr
P019656	Carefree Protect Black tar 2,5 ltr
P019657	Carefree Protect Bangkirai oil 0,75 ltr
P019658	Carefree Protect Decking oil 2,5 ltr
P019659	Carefree Protect Hardwood oil 0,75 ltr





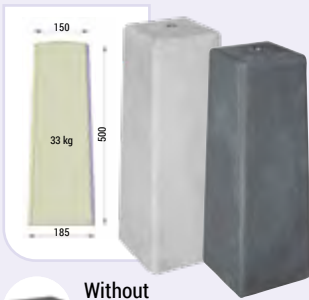

BERTON® PAD FOOTING ECO

- Anthracite or grey
- (18x18)>(15x15)x50cm
- With rounded edges
- M16 coupler

P003824 White/grey
P003825 Anthracite



Without bevelled edges, small curve

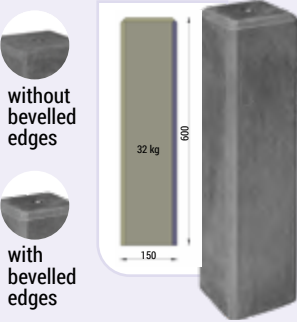

BERTON® PAD FOOTING

- Anthracite

P003821 M16 coupler without bevelled edges 15x15x60cm

P003820 M16 coupler with bevelled edges 15x15x60cm

P003822 M20 coupler with bevelled edges 15x15x60cm

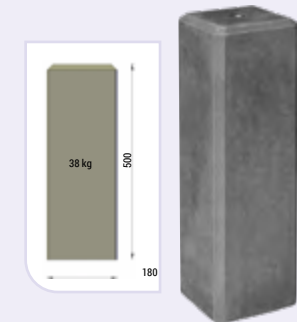

BERTON® PAD FOOTING

- Anthracite
- 18x18x50cm
- With bevelled edges
- M20 coupler

P003823

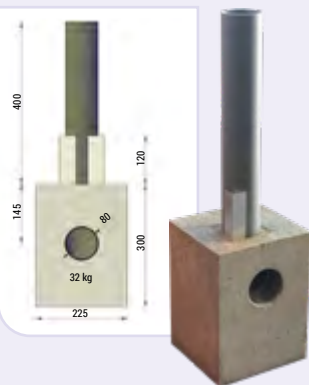

BERTON® PAD FOOTING WITH DRAIN

- White/grey
- 22x22x30cm
- Foundation base for porch
- Drain Ø8x45cm

P003830

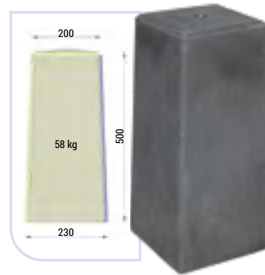

BERTON® PAD FOOTING XL

- Anthracite
- 20x23.5x50cm
- With rounded edges
- M20 coupler

P003833

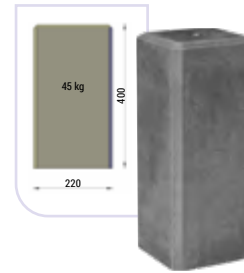

BERTON® PAD FOOTING XXL

- Anthracite
- M20 coupler

P003834 22x22x40cm with bevelled edges
P084771 20x20x50cm without bevelled edges

NEW

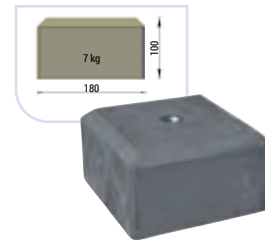

BERTON® HALF MODEL PAD FOOTING

- Anthracite
- 18x18x10cm
- With bevelled edges
- M20 coupler

P003836



BERTON® PAD FOOTING BLOCK

- 14x14x50cm
- Footing Block 28x28cm
- Without bevelled edges
- M16 coupler

P003835

CONCRETE FOOTINGS

The concrete footings guarantee a good foundation! In addition, the footing ensures that the upright is above the water level, which makes the wood last even longer.



BERTON® SINKING PREVENTION

- Anthracite
- Diameter 25cm
- Thickness 5cm

P003937



HEIGHT ADJUSTMENT

- M16
- 10x10cm
- Thickness 3mm
- Welded nut and 16mm rod

P004761 Galvanised
P018806 Stainless steel

**HEIGHT ADJUSTMENT DELUXE**

- Thickness: 3mm
- Including screw nut and screw end

P018813 Galvanised M16 8x8cm
P018807 Galvanised M16 10x10cm
P018808 Galvanised M20 10x10cm
P018810 Stainless steel M16 8x8cm
P018811 Stainless steel M16 10x10cm
P018812 Stainless steel M20 10x10cm

**CLAMP HEIGHT ADJUSTMENT GALVANISED**

- Galvanised M16
- Thickness: 3mm
- For posts 12-20cm

P018809

**CONCRETE MORTAR**

- Ready-made, just add water

P018875 Quick-drying concrete
P018876 Concrete mortar

WOOD PELLETS

Wood pellets are a popular heat source. Central-heating boilers are becoming increasingly expensive to operate, so pellet stoves are gaining in popularity. Our high-quality wood pellets ensure good efficiency from your pellet stove. The pellets are made out of compressed sawdust. This waste flow is sourced from sawmills where Tuindeco products are made. This allows us to guarantee that the wood comes from responsibly managed forests.

**WOOD PELLETS**

- Packed in 15 kg bags
- 65 bags on a pallet
- Diameter 6mm
- EnplusA1 quality

P004462

Tuindeco supplies wood pellets to dealers by pallet or full truck. Ask your Tuindeco dealer for prices and possible sales of individual bags

**ADVANTAGES OF WOOD PELLETS**

- Lower heating costs than gas
- Green fuel
- Very environmentally friendly
- High efficiency



FOUNDATION



standard

FOUNDATION BEAM PINE

- 4.5x9x300cm
- Impregnated, planed
- With drainage profile

P020121



standard

robust

FOUNDATION BEAM PLASTIC

- 3.5x8.5x300cm
- With drainage profile

P020122 Standard
P020123 Robust



FOUNDATION BEAM HARDWOOD

- 4.5x9x300cm
- Untreated, planed
- Finger-joined to prevent warping as much as possible
- With drainage profile

P002441



HARDWOOD GIRDER

- Untreated, fine sawn

P019076 4x20x300cm
P019077 4x20x400cm
P019078 4x20x500cm

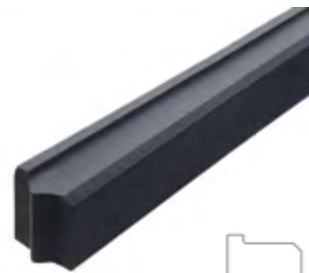

CONCRETE BAND

- Afmeting: 10x15x100cm
- Colour: Charcoal
- This unique patented product is a result of our successful foundation bar, which has been around for years. The result is a concrete belt with a drainage profile, unique in the market

P003837



SYNTHETIC ADJUSTABLE FLOOR SUPPORT

- Adjustable and made from new plastic

P002630 Pedestal-1
3-6 cm Max. load bearing 450kg
P002631 Pedestal-2
6-14 cm Max. load bearing 1400kg



Floor packs for your log cabin

Excellent solid floor parquet 18mm

P006695 18mm, parquet length 250cm

P006696 18mm, parquet length 200cm

Impregnated floor parquet

P027042 Green

CH027751 Honey yellow

P027043 Brown

CH027751 Red Class Wood

P027044 Silver grey

Impregnation colours:



Contents

10 untreated floor panels 1.8x9.6cm, 3 impregnated floor beams 4.5x4.5cm, and 2 untreated plinths 1.6x4cm. This is enough for 2.15m².

Excellent solid floor parquet 26mm

P006694 26mm, parquet length 250cm

P006697 26mm, parquet length 200cm

Impregnated floor parquet

P027039 Green

P027078 Honey yellow

P027039 Brown

CH027743 Red Class Wood

P027039 Silver grey

Impregnation colours:



Contents

5 untreated floor panels 2.6x14.5cm, 3 impregnated floor beams 4.5x4.5cm, and 2 untreated plinths 1.6x4cm. This is enough for 1.66m².

One floor pack is enough for 1.66m² or 2.15m² and is made of spruce wood



Profiles

H/U profiles

- Untreated, planed spruce

P013218	28/34mm 220cm is suitable for walls of 28mm and 34mm
P013219	45/58mm 220cm is suitable for walls of 45mm en 58mm



Log cabin profiles

- Untreated, planed spruce
- Can be ordered per m'

P013927	19mm
P013928	28mm
P013929	34mm
P013930	40mm
P013931	44mm
P013932	58mm
P013933	70mm

Add an extra layer to the walls of your log cabin by fitting these log cabin profiles

Startersets

The startersets consists of:

- 1 storm anchor set
- 1 air vent for log cabins
- 1 garden house kit small (starterset 1) or
- 1 garden house kit large (starterset 2) or
- 2 garden house kits large (starterset 3)

P021784	Starterset 1
P021785	Starterset 2
P021786	Starterset 3

Storm anchor set

1

- Including bolts
- Set of 4 pieces

P020110 Storm anchor set

Air vent

2

- Dimensions 13x9cm
- Including fitting kit
- Set of 2 pieces

P002444 Air vent

Nails and asphalt nails

3

P020111	Asphalt nails galvanised 3x15mm (200 pieces)
P020112	8 Roof board nails 2.4x50mm (200 pieces)
P020113	Garden house kit (800 nails/800 asphalt nails)
P020114	Garden house kit (800 nails/200 asphalt nails)



**ROOF SHINGLES STRAIGHT**Per pack of 3m²

P020544	Black
P020545	Red
P020546	Green
P020547	Blue
P020548	Brown

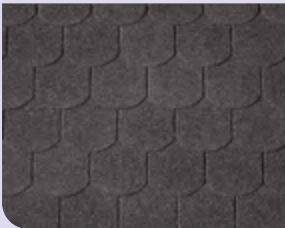
**ROOF SHINGLES
BEAVERTAIL**Per pack of 3m²

P020552	Black
P020553	Red
P020554	Green

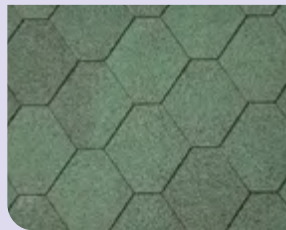
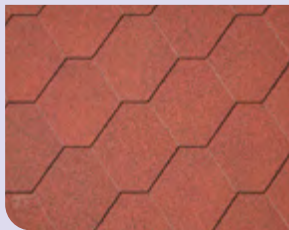
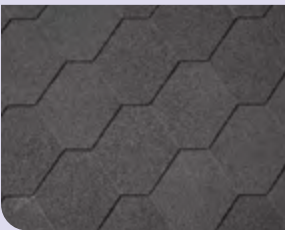
**ROOF SHINGLES
HEXAGONAL**Per pack of 3m²

P020555	Black
P020556	Red
P020557	Green

FINIALS AND ACCESSOIRES**FINIAL (WITHOUT
BRASS BALL FINIAL)**

- Square roof
- Colour: black

P002436

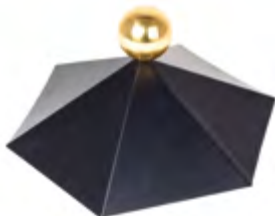
**FINIAL (WITHOUT
BRASS BALL FINIAL)**

- Hexagonal roof
- Colour: black

P002438

**FINIAL (WITHOUT
BRASS BALL FINIAL)**

- Octagonal roof
- Colour: black

P002437

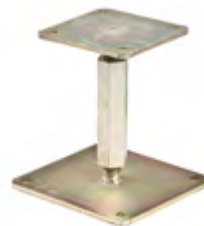
**ADJUSTABLE POST SUPPORT**

- Dimensions top plate: 12x12cm
- Dimensions base plate: 16x16cm
- Height adjustable: 14-20cm

P002607

**BRASS BALL FOR FINIAL**

P002440

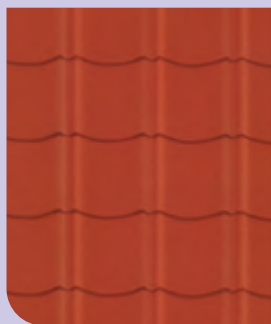

**EASYPAN**

■ 86x113.5cm

P020509 Smooth red
P020505 Smooth anthracite

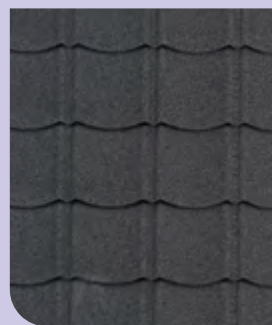
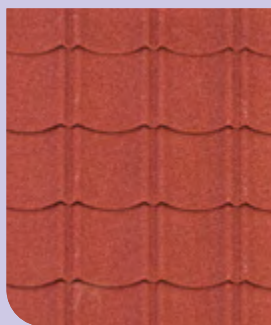
**AQUAPAN**

■ 86x113.5cm

P020534 Red
P020539 Anthracite

ADVANTAGES OF AQUAPAN

- The metal is finished with an aluminium zinc coating
- Very easy to install without cutting or sawing
- Weights only 6kg/m²
- Granulate finishing for the aquapan, therefore no shiny surface area

Minimum roof angle 10 degrees.
 To prevent condensation and damp formation we advise that you use roofing felt as an underlayer

**AQUAPAN/EASYPAN SCREWS**

■ Ø4.8x20mm

P020535 Aquapan red
P020540 Aquapan anthracite
 (per 40 pcs/6 per plate)

**WIND STOP 91CM**

P020538 Aquapan red
P020543 Aquapan anthracite
P020512 Easypan red
P020508 Easypan anthracite
 (effective 81cm)

**RIDGE TILE 91CM**

P020536 Aquapan red
P020541 Aquapan anthracite
P020510 Easypan red
P020506 Easypan anthracite
 (effective 81cm)

**SHUTTER**

P020537 Aquapan red
P020542 Aquapan anthracite
P020511 Easypan red
P020507 Easypan anthracite
 (2 pcs per roof)

**ROOF TILE PROFILE BOARDS**

- Roof tile profile boards 0.5mm
- Roof underlay membrane
- Tile batten, ridge tiles, fitting kit

P018700 Black, per m²
P018703 Mat black, per m²
P018701 Terracotta, per m²
P018702 Anthracite, per m²





COVERING AND ACCESSORIES

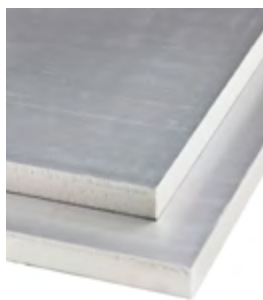

ROOF INSULATION PANEL

- Thickness: 3cm
- RC value 1.36 m²k/w

P020549 Roof insulation panel
60x120cm

P020513 Roof underlay membrane
120gr/m² 1.5x50m

P020550 Pressure distribution plate
for roof panel 70mm

P020551 Screws for pressure distribution
plate Ø5x4.5mm



EPDM TO SPECIFICATION

- Thickness 1.14 mm, incl. glue
- Custom order

P018704



URBAN GROMMET SQUARE

- Colour: black
- Protrudes from the fascia board
at the lowest side between roof
and rain pipe

P020962 Square

P020963 RW connector



EDGING STRIP

K064964 Straight aluminium
4.5x4.5x250cm

K064966 Outer corner aluminium
4.5x4.5x50cm

P020116 Coupling element for
aluminium

K064965 Straight black
4.5x4.5x250cm

K064967 Outer corner black edging strip
4.5x4.5x50cm

P004146 Coupling element for black edging strip



EASY-ROOFING ALUMINIUM

- Roll of 5m² (100x500cm)
- Minimum overlap of
10cm required

P020558



ROOFING FELT GREY

- Width 100 cm
- Effective width 90 cm

P088749 Pro roll 6.5m²

P088748 Pro roll 10m²



ROOF DUCT ROUND

P020960 Round
Ø6.3x30cm

P020961 Sliding sleeve
Ø6cm



EPDM CONTACT ADHESIVE

P020560 Tube 0.29ltr

P020559 Spray can 0.75ltr

BITUMEN SEALANT

- Colour: black
- For roof shingles/roofing felt

P020561 Tube 0.31ltr



We supply customized roof tile profile sheets for all outdoor enclosures!



Plastic roof gutters



PLASTIC GUTTER SET CONSISTING OF:

- Gutter
- Gutter corner piece
- Rainwater drainage bracket
- Coupling element
- End cap
- Downspout
- Elbow 67°
- Adhesive 125 ml
- Gutter brackets

Gutter set 65mm black

- P020129** Gutter set complete for 2 sides 400cm (total 800cm gutter)
P020134 Gutter set complete for 4 sides 400cm (total 1600cm gutter)
P020130 Extension set for 2 sides 200cm (to extend gutter set P020129 on 2 sides)
P020132 Extension set for 4 sides 200cm (to extend gutter set P020134 on 4 sides)
P020131 Extra outlet set for rainwater, needed for gutters over 500cm (for 2 sides)
P020133 Extra outlet set for rainwater, needed for gutters over 500cm (for 4 sides)

Gutter set 100mm black

- P020135** Gutter set complete for 2 sides 500cm (total 1000cm gutter)
P020140 Gutter set complete for 4 sides 500cm (total 2000cm gutter)
P020136 Extension set for 2 sides 200cm (to extend gutter set P020135 on 2 sides)
P020138 Extension set for 4 sides 200cm (to extend gutter set 40.5530Z on 4 sides)
P020137 Extra outlet set for rainwater, needed for gutters over 600cm (for 2 sides)
P020139 Extra outlet set for rainwater, needed for gutters over 600cm (for 4 side)

Loose parts plastic gutters

- P020144** Gutter 65mm (200cm)
P020141 Gutter bracket 65mm
P020145 Gutter coupling element 65mm
P025853 Gutter corner piece 65mm
P020156 Gutter outer corner 65mm
P020142 End piece 65mm
P020143 Gutter outlet 65>60mm

- P020153** Gutter 100mm
P020148 Gutter bracket 100mm
P020154 Gutter coupling element 100mm
P020155 Gutter corner piece 100mm
P020152 Gutter outer corner 100mm
P020149 Gutter end piece left 100mm
P020150 Gutter end piece right 100mm
P020151 Gutter outlet 100mm

- P020146** Elbow 67°
P020157 Downspout (200cm)
P020158 Wall bracket

The diameter of the rainwater discharge (HWA) components is 60mm in both the 65mm and 100mm gutters. Therefore, choose the right gutter outlet to connect the gutter to the HWA.

Galvanised roof gutters



GALVANISED GUTTER SET CONSISTING OF:

- Gutter
- Gutter brackets
- Coupling element
- Elbow 45°
- End cap
- Gutter corner piece
- Downspout
- Rainwater drainage bracket

Gutter set 125mm galvanised

- P021788** Gutter set complete for 2 sides 300cm (total 600cm gutter)
P021787 Gutter set complete for 2 sides 600cm (total 1200cm gutter)
P021789 Gutter set complete for 4 sides 600cm (total 2400cm gutter)

Gutter set complete for 2 sides 300cm can also be used as an extension set to extend the above sets.

Loose parts galvanised gutters

- P002642** Gutter (300cm)
K064968 Gutter bracket
P002637 Gutter connector
P002647 Outer corner
P002638 End piece
P002639 Gutter drop
P002641 Connecting pipe between outlet and pipe
P002640 Elbow 45°
P002636 Downspout (300cm)
P002644 Wall bracket
P002645 Screw-in pen
P002646 Bended gutter outflow (with standing seam)

The diameter of the rainwater drainage parts is 80mm. Connect the gutter with the gutter outlet and the connecting piece.





A roof is only truly finished when it is equipped with lighting. With our energy-efficient LED spotlights, you can continue to enjoy your garden in the evening and create an atmospheric look.

TUINDECO LIGHTING



TRANSFORMER/DISTRIBUTOR

- For 12 recessed spotlights and/or wall lights
- Remote control with dimming function included

P020716



RECESSED SPOTLIGHTS

- 1x 3 Watt
- Light colour warm white 2700K
- Dimensions: 3.7x3.0cm (installation size 3.0cm)
- Available per set of 2
- 5 metre cable included

P020718



WALL LIGHTS

- Up & down light
- 2x 1,5 Watt
- Light colour warm white 2700K
- Dimensions 5.5x8.5cm
- Available individually
- 7 metre cable included

P020717



5 METRE EXTENSION CABLE

- To extend the standard cable supplied with a recessed spotlight or wall light

P020721



ROUND HOLE SAW

- To cut the correct hole for recessed spotlights

P020720



BLACK WALL SHELF

- To conceal the cabling and transformer/distributor
- Dimensions: 15x8.5x23cm

P020719

DESIGN YOUR OWN LIGHTING WITH BLACK WALL LIGHTS AND RECESSED SPOTLIGHTS FROM TUINDECO

This lighting is connected to a 230-volt socket (mA value 700). Follow the step-by-step guide to assemble a complete set.

Step-by-step guide

- 1 Select a transformer
- 2 Select the required number of spotlights
- 3 Add accessories

If you are looking to control more than 12 spotlights using one remote, create several groups on one remote or control the spotlights with an app, we have several options to help you do so. For more information, contact your TuindecO dealer.



Insulating log cabins from the inside

new

The package contains the following parts:

1 piece	Climate foil for the outside wall (to be fitted on the inside wall)	
3 pieces	Beams	4,4x4,4x220cm
9 pieces	Metal corners with oval hole on one side	
16 pieces	Wooden spacers	
4 pieces	PIR insulation boards	3,0x60x120cm
1 piece	Climate foil for inner wall	
20 pieces	Tongue and groove boards for interior lining	1,8x12x128,8cm

Excluding screws/nails

Specifications::

- the package is sufficient for walls of 220x100cm
- the package is universal for all log cabins
- the package covers an area of 2,8m²

K067746



Scan here for an
building instruction
video



ORDER OVERVIEW GLASS SLIDING WALLS

- Incl. top and bottom rails + sliding glass doors
- Fitted with 10mm thick laminated safety glass
- Available in heights from 198 to 252cm
- Available in two widths
- Available in two colours
- Under rails contains holes for water drainage

**Accessories
can be ordered
separately!
(pages 3-4)**

Ordering steps

1. Determine the width of the daylight size
2. Choose the door width (82 or 98cm)
3. Determine the height of the threshold height
5. Choose the rail/doorset colour
6. Select correct part numbers from table
7. Complete the sliding wall with accessories (pages 3-4)

	Width of threshold (cm)	Door width (cm)	Height of threshold (cm)	Anthracite (RAL 7024)	Black (RAL 9005)	Glass size (cm)	Rail set length (cm)	
3 tracks								Additional product specifications
	Width up to 242	82	198-202	P020637	P020659	H190xB82	300	
	Width up to 242	82	208-212	P020639	P020661	H200xB82	300	
	Width up to 242	82	213-217	P020640	P020662	H205xB82	300	
	Width up to 242	82	218-222	P020641	P020663	H210xB82	300	
	Width up to 242	82	223-227	P020642	P020664	H215xB82	300	
	Width up to 242	82	228-232	P020643	P020665	H220xB82	300	
	Width up to 242	82	238-242	P020645	P020667	H230xB82	300	
	Width up to 290	98	198-202	P020624	P020646	H190xB98	300	
	Width up to 290	98	208-212	P020626	P020648	H200xB98	300	
	Width up to 290	98	213-217	P020627	P020649	H205xB98	300	
	Width up to 290	98	218-222	P020628	P020650	H210xB98	300	
	Width up to 290	98	223-227	P020629	P020651	H215xB98	300	
	Width up to 290	98	228-232	P020630	P020652	H220xB98	300	
	Width up to 290	98	238-242	P020632	P020654	H230xB98	300	
	Width up to 290	98	248-252	P020634	P020656	H240xB98	300	
4 tracks								
	Width up to 322	82	198-202	P020683	P020705	H190xB82	390	
	Width up to 322	82	208-212	P020685	P020707	H200xB82	390	
	Width up to 322	82	213-217	P020686	P020708	H205xB82	390	
	Width up to 322	82	218-222	P020687	P020709	H210xB82	390	
	Width up to 322	82	223-227	P020688	P020710	H215xB82	390	
	Width up to 322	82	228-232	P020689	P020711	H220xB82	390	
	Width up to 322	82	238-242	P020691	P020713	H230xB82	390	
	Width up to 386	98	198-202	P020670	P020692	H190xB98	390	
	Width up to 386	98	208-212	P020672	P020694	H200xB98	390	
	Width up to 386	98	213-217	P020673	P020695	H205xB98	390	
	Width up to 386	98	218-222	P020674	P020696	H210xB98	390	
	Width up to 386	98	223-227	P020675	P020697	H215xB98	390	
	Width up to 386	98	228-232	P020676	P020698	H220xB98	390	
	Width up to 386	98	238-242	P020678	P020700	H230xB98	390	
	Width up to 386	98	248-252	P020680	P020702	H240xB98	390	

1. Determine the width of the threshold dimension; this is the distance between the two threshold edges, or the inside dimension of an opening from left to right. The number of tracks is also calculated on this basis. Look up the relevant width in the order table above. 2. Choose the desired door width and take into account the maximum track length. 3. Determine the correct threshold height, the inside dimension of the opening from top to bottom, based on this the height of the glass panels is determined. Look up the required height in the table. 4. Choose the correct article number based on the desired colour (for the colour anthracite the bottom profile is delivered in aluminium colour, for black the bottom profile is black).

Width of threshold (cm)	Door width (cm)	Height of threshold (cm)	Anthracite (RAL 7024)	Black (RAL 9005)	Glass size (cm)	Rail set length (cm)	Additional product specifications
5 tracks							
Width up to 402	82	198-202	P020735	P020757	H190xB82	490	
Width up to 402	82	208-212	P020737	P020759	H200xB82	490	
Width up to 402	82	213-217	P020738	P020760	H205xB82	490	
Width up to 402	82	218-222	P020739	P020761	H210xB82	490	
Width up to 402	82	223-227	P020740	P020762	H215xB82	490	
Width up to 402	82	228-232	P020741	P020763	H220xB82	490	
Width up to 402	82	238-242	P020743	P020765	H230xB82	490	
Width up to 482	98	198-202	P020722	P020744	H190xB98	490	
Width up to 482	98	208-212	P020724	P020746	H200xB98	490	
Width up to 482	98	213-217	P020725	P020747	H205xB98	490	
Width up to 482	98	218-222	P020726	P020748	H210xB98	490	
Width up to 482	98	223-227	P020727	P020749	H215xB98	490	
Width up to 482	98	228-232	P020728	P020750	H220xB98	490	
Width up to 482	98	238-242	P020730	P020752	H230xB98	490	
Width up to 482	98	248-252	P020732	P020754	H240xB98	490	
6 tracks							
Width up to 482	82	198-202	P020781	P020803	H190xB82	590	
Width up to 482	82	208-212	P020783	P020805	H200xB82	590	
Width up to 482	82	213-217	P020784	P020806	H205xB82	590	
Width up to 482	82	218-222	P020785	P020807	H210xB82	590	
Width up to 482	82	223-227	P020786	P020808	H215xB82	590	
Width up to 482	82	228-232	P020787	P020809	H220xB82	590	
Width up to 482	82	238-242	P020789	P020811	H230xB82	590	
Width up to 578	98	198-202	P020768	P020790	H190xB98	590	
Width up to 578	98	208-212	P020770	P020792	H200xB98	590	
Width up to 578	98	213-217	P020771	P020793	H205xB98	590	
Width up to 578	98	218-222	P020772	P020794	H210xB98	590	
Width up to 578	98	223-227	P020773	P020795	H215xB98	590	
Width up to 578	98	228-232	P020774	P020796	H220xB98	590	
Width up to 578	98	238-242	P020776	P020798	H230xB98	590	
Width up to 578	98	248-252	P020778	P020800	H240xB98	590	

1. Determine the width of the threshold dimension; this is the distance between the two threshold edges, or the inside dimension of an opening from left to right. The number of tracks is also calculated on this basis. Look up the relevant width in the order table above. 2. Choose the desired door width and take into account the maximum track length. 3. Determine the correct threshold height, the inside dimension of the opening from top to bottom, based on this the height of the glass panels is determined. Look up the required height in the table. 4. Choose the correct article number based on the desired colour (for the colour anthracite the bottom profile is delivered in aluminium colour, for black the bottom profile is black).



Order a sample case for €250! P126123



ACCESSOIRES

Side guide kits (290cm high) Anthracite Black

Side guide kits (290cm high)	Anthracite	Black
3 tracks set	P020668	P020669
4 tracks set	P020714	P020715
5 tracks set	P020766	P020767
6 tracks set	P020812	P020813

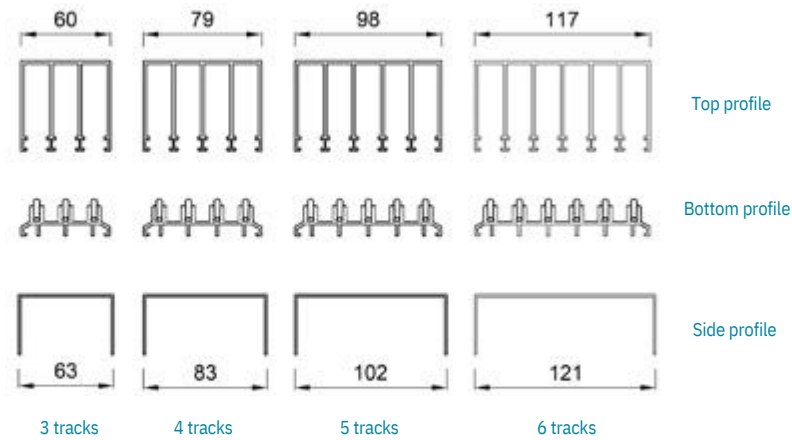

Support/foundation beam aluminium tube Antraciet Black

6.0x3.0x600cm	P085595	P086523
6.0x11.0x600cm	P085596	P086524
11.0x11.0x600cm	P020621	P086522





INDUSTRIAL-LOOK RODS

Steel-look glass rods create an industrial look, with the advantages of aluminium material. The panels can be installed as you see fit and are fully customisable. The only requirement is a glass thickness of 10mm.

P085597 STEEL-LOOK SET PER PANEL

Consists of:
2 pieces black U-profile 250cm
2 pieces rubber 250cm
3 pieces rod strip 210cm

Please note; the stem-look sets cannot be combined with the draught brushes



Order a sample case for €250! P126123

DOOR HANDLES

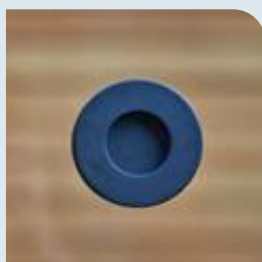

P085588
Door handle stainless steel round black
Set of 2



P020610
Doorhandle stainless steel round
Set of 2



P085589
Doorhandle aluminium oval
Set of 2

PANEL CATCHES

P085594 Universal
Vear example: If you choose a 3 trackse wall, you need to order 4 carriers; (number of tracks x 2) - 2 = number of flights

LOCKS

P085590 Centre lock set anthracite
P085591 Side lock set anthracite
P085592 Centre lock set black
P085593 Side lock set black

Only possible with carriers

DRAUGHT EXCLUDERS

P020612 Draught excluder anthracite
P020613 Draught excluder black

Number of tracks minus 1
Example: for a 3-track set, 2 draught bolts

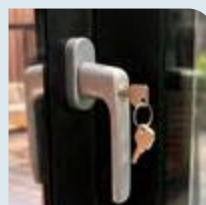

These locking systems not only look good but also provide user convenience and security